



PASCO 850 Universal Interface

Model No. UI-5000



Table of Contents

Equipment List	3
Introduction	4
Computer Requirements for the 850 Universal Interface	4
General Operation Requirements and Setup.....	5
A. Operation Requirements and Precautions	5
B. Connecting the 850 Universal Interface to Your Computer	5
C. Starting the 850 Universal Interface	6
D. Plugging a Sensor into the 850 Universal Interface	6
E. Changing Interfaces Between Experiments.....	6
Using the Interface with PASCO Capstone Software	7
A. Setup.....	8
B. Displays	9
C. Collect Data - the Controls Palette	11
D. More Information About PASCO Capstone	11
Using the 850 Interface as a Signal Generator	12
A. Connect the Interface	12
B. Signal Generator Controls: 850 Output 1	13
C. Signal Generator Controls: 850 Outputs 2 and 3	15
D. Set up an Example Output Signal	16
E. View the Output Signal in a Capstone Display	16
Troubleshooting.....	17
Appendix A: Specifications.....	19
Appendix B: Electromagnetic Compliance.....	21
Appendix C: Frequently Asked Questions	22
Technical Support.....	24
Warranty, Copyright and Trademark Information	24
Product End of Life Disposal Information	24

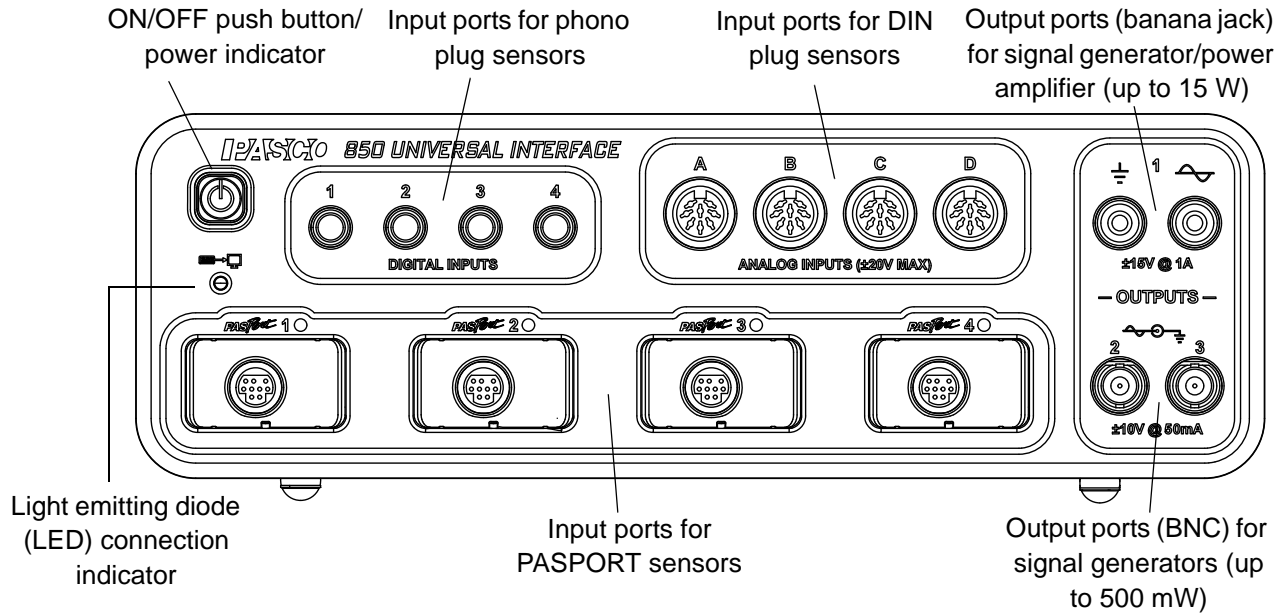

Equipment

Included Equipment
1. 850 Universal Interface (UI-5000)
2. AC Adapter, 100-240 V AC to 20 V DC at 6 A (120 W), with power cord
3. USB cable

Additional Equipment Required	Note
USB-compatible computer	
Any PASCO [®] sensor	A sensor with a PS-, CI-, ME-, SN-, or TD- prefix*
PASCO Capstone™ software	UI-5400 site license or UI-5401 single user license

* Any PASPORT[®] or ScienceWorkshop[®] sensor can be used for real-time data collection. See the PASCO web site at www.pasco.com for more information.

Additional Equipment Recommended	Model Number
Banana Plug Patch Cords (for Output 1)	SE-9750 and SE-9751
BNC to Banana Plug Cords (for Outputs 2 and 3)	UI-5119 and UI-5219

Introduction

Interface

The PASCO[®] 850 Universal Interface is a USB (Universal Serial Bus) multi-port data acquisition interface designed for use with any PASCO sensor and PASCO Capstone[™] software (available separately). Users can plug a sensor into one of the twelve input ports on the interface, perform the necessary setup in the PASCO Capstone program, and then begin collecting data. PASCO Capstone software records, displays and analyzes the data measured by the sensor.

The 850 Universal Interface comes with a USB cable for connecting to a computer, and a power supply (AC adapter with power cord) that converts input of 100 to 240 V AC to output of 20 V DC at 6 A.



USB Cable

Power Adapter

Power Cord

The 850 Universal Interface has three built-in signal generator/power outputs. One provides up to 15 watts of power and the other two provide 500 milliwatts of power each. The interface can output direct current (DC) or alternating current (AC) in a variety of waveforms such as sine, square, and sawtooth.

(Please note that the 850 Universal Interface is not compatible with the PASCO CI-6552A Power Amplifier because there is no ‘signal output’ from the DIN plug ports.)

Note: The 850 Universal Interface is compatible with all PASCO PASPORT sensors and *ScienceWorkshop* sensors. The PASPORT sensors have a “PS-” prefix, and the *ScienceWorkshop* sensors have a “CI-”, “ME-”, “SN-”, or “TD-” prefix. See the PASCO web site at www.pasco.com for more information about the sensors.

Software

PASCO Capstone software, available separately, is required for the 850 Universal Interface, but please note that PASCO Capstone supports *any* PASCO USB interface, such as the following:

- SPARK Science Learning System[™] (PS-2008A)
- SPARKlink[™] Interface (PS-2009)
- USB Link (PS-2100)
- PowerLink (PS-2001)
- Xplorer GLX Graphing Datalogger (PS-2002)
- Xplorer Datalogger (PS-2000)

PASCO Capstone software can also work with the following *ScienceWorkshop* USB interfaces, but only with one interface at a time.

- 750 *ScienceWorkshop* USB Interface (CI-7650)
- 500 *ScienceWorkshop* Interface (CI-6400) with the USB/Serial Converter (CI-6759A)

Finally, PASCO Capstone software will work with the PI-8127 Function Generator. (Select Instruments from the Sensor Type menu.)

- *Note: Capstone does not support the “download logged data” feature for the Xplorer and the 500 ScienceWorkshop interface.*

Multiple Interfaces

PASCO Capstone software can support more than one PASPORT interface at the same time. For example, the user can connect the 850 Universal Interface, a USB Link, and a PowerLink to the computer, and use them simultaneously. The user can also use PASCO Capstone software to select which of the connected interfaces to use.

Computer Requirements for the 850 Universal Interface

Windows®-Based Computers: Intel Pentium® (or higher) processor with one or more USB ports, and Windows™ XP or higher. [The interface cannot be used with Windows 3.1, 95, ME, 2000, or NT 4.0].

General Operation Requirements and Setup

A. Operation Requirements and Precautions

- a) The 850 Universal Interface requires PASCO Capstone software. (The interface will not work with PASCO’s DataStudio software.) However, PASCO Capstone software will also work with all PASCO USB interfaces, as well as the USB 750 *ScienceWorkshop* Interface and the 500 *ScienceWorkshop* Interface with a USB/Serial adapter.
- b) The included power supply (AC adapter) and USB cable are required for operation. Always plug the power cord of the AC adapter into a standard, grounded wall outlet.



WARNING: The interface is not water-proof. To avoid the risk of shock, keep the interface, AC adapter, and cable away from water and liquids. If conducting an experiment with liquids or water, keep the liquid container away from the interface. For maximum protection, keep liquids in closed containers.

Also during operation, do not cover the heat sink “fins” on the back of the interface box. The fins help prevent the interface from overheating during prolonged use.

B. Connecting the 850 Universal Interface to Your Computer

1. Install PASCO Capstone software on your computer.
2. Connect the larger end of the USB cable to a USB port on the computer.

3. Connect the smaller end of the USB cable to the USB port on the back of the interface.
4. Connect the AC adapter plug to the power jack on the back of the interface box. Connect the AC adapter power cord to a grounded wall outlet.

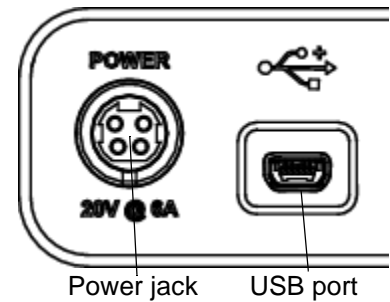

C. Starting the 850 Universal Interface

1. On the left front corner of the interface, firmly press and hold the power push button. The interface will “beep” once and the green light emitting diodes (LEDs) above the PASPORT input ports will blink once. The push button has a blue LED that shines when the power is on.
2. The green LED connection indicator below the power push button should light up. If not, check the connection between the interface and the computer.

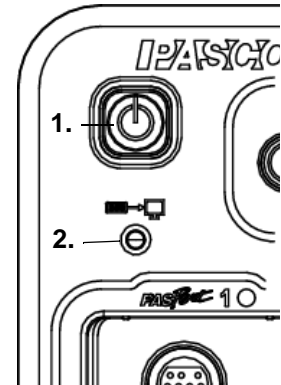

1, Power push button
2, LED connection indicator

D. Plugging a Sensor into the 850 Universal Interface

- PASPORT sensors plug into input ports labeled **PASPort**.
- *ScienceWorkshop* analog sensors with DIN connectors plug into the ANALOG INPUTS labeled A, B, C, and D on the interface.
- *ScienceWorkshop* digital sensors with stereo phono plugs connect into the DIGITAL INPUTS labeled 1, 2, 3, and 4 on the interface.

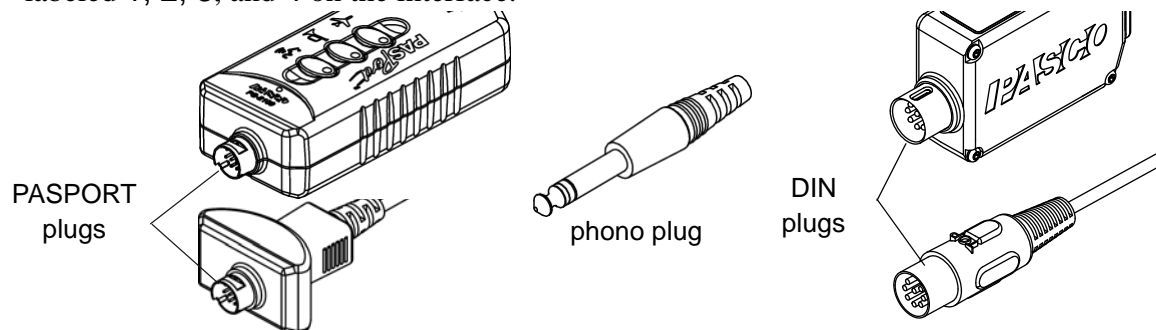

Extender Cables

If you need extra distance between the sensor and the 850 Universal Interface, use an extender cable such as the UI-5218 8 pin 1.8 m DIN Extender Cable, the PS-2500 PASPORT Sensor Extension Cable, or the PI-8117 Phono Jack Extender Cable.

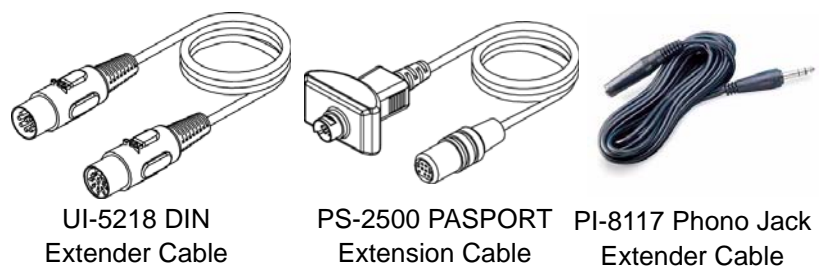

Please note that the 8-Pin DIN Cable Assembly that is included with several *ScienceWorkshop* sensors such as the CI-6504A Light Sensor can also be used as an extension cable.

DO NOT connect more than one extender cable between a sensor and the 850 Universal Interface. Connect the sensor directly to the interface or, at most, through one extender cable to the interface.

Using the Interface with PASCO Capstone Software

1. Connect a PASPORT or *ScienceWorkshop* sensor to an input port on the interface.
2. Start PASCO Capstone.

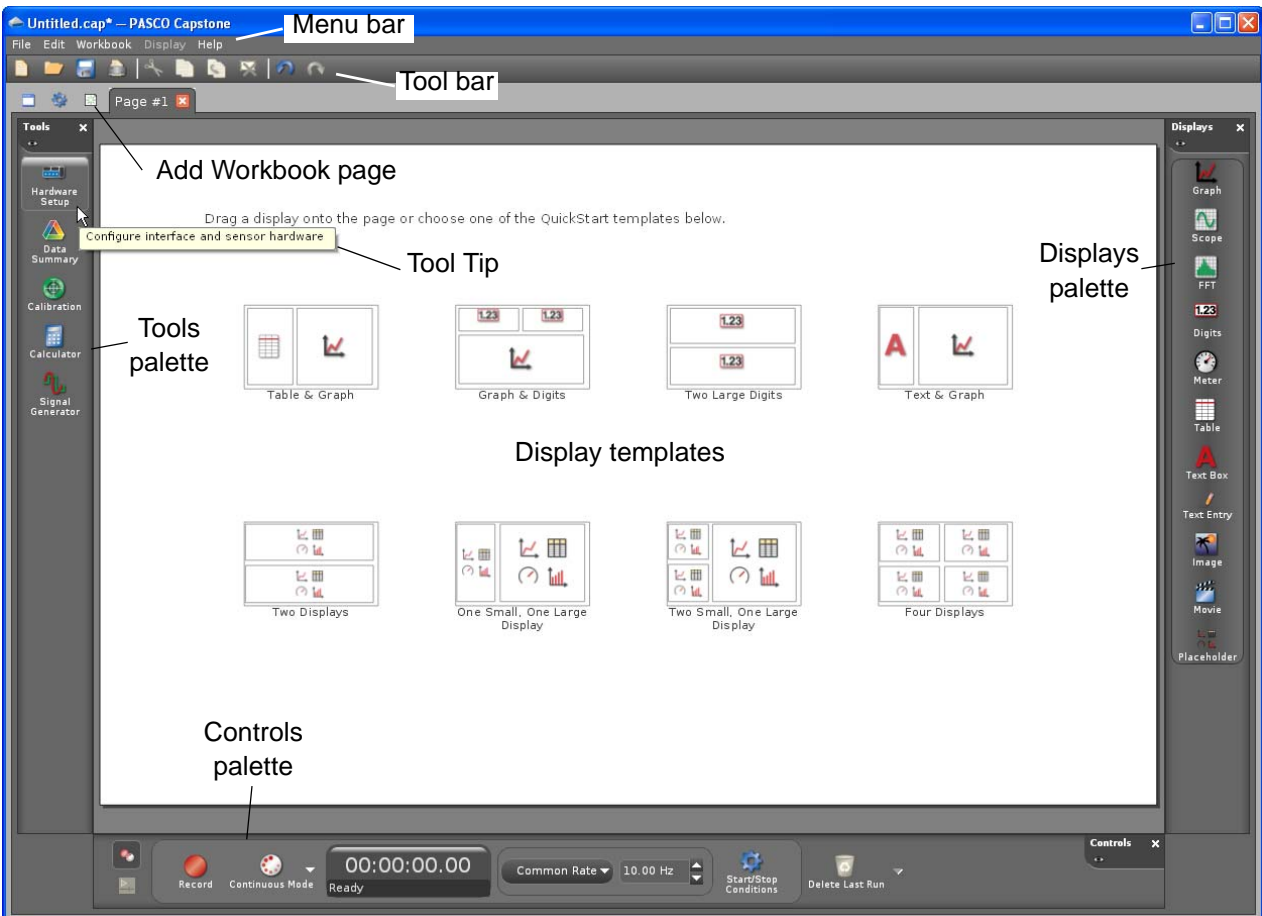

- The main element is the Workbook page.
- Above the Workbook page are the Menu bar and Tool bar.
- To the left, right, and below the Workbook page are the Tools palette, the Displays palette, and the Controls palette.
- Hover the cursor over an icon, button, or other element to see a descriptive Tool Tip.

Refer to the **Help** menu in the menu bar and the online *PASCO Capstone User's Guide* for more information about the *Workbook* page and the palettes.

A. Setup

- In the Tools palette, click the Hardware Setup button. The Hardware Setup panel opens with a picture of the attached interface(s).
 - If the interface automatically recognizes the sensor* that you plugged into one of its inputs, then the sensor's icon will also appear in the picture with the interface.
 - At the bottom of the Hardware Setup panel is the name of the sensor. The gear shaped button to the right of the name opens the Sensor Properties dialog window (not shown).
 - Below the name of the sensor are the Choose Interface and Add Sensor/Instrument buttons.
- Click Choose Interface to open a dialog window of interface choices. Click Manual to expand the list of choices. Each connected interface is indicated by a check mark.

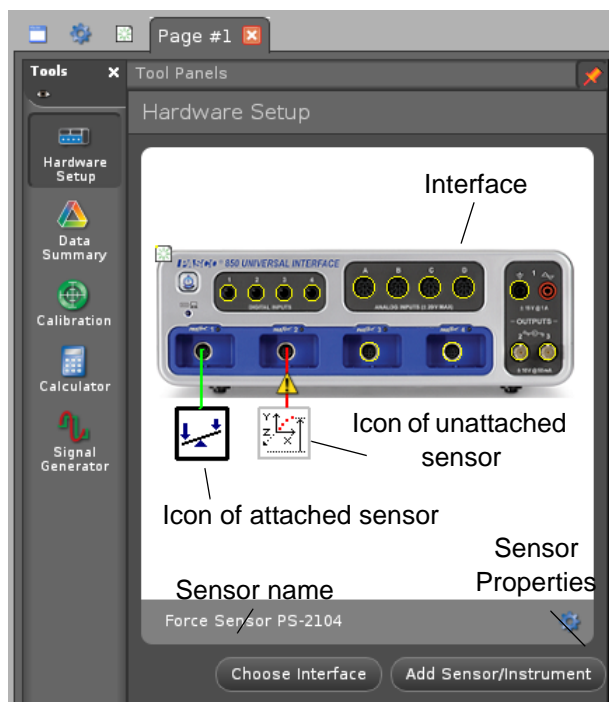

Hardware Setup panel



Choose Interface... window

*In general, the interface automatically recognizes all PASPORT sensors.

In this example, the Force Sensor PS-2104 is connected to the first PASPORT input port.

NOTE: If a PASPORT sensor has been selected for an input but the sensor is not yet connected to the interface, the sensor's icon is slightly different.

(⚠) The exclamation mark triangle indicates that the sensor is not connected or detected.

- Click Add Sensor/Instrument to open the dialog window showing Sensor Type and Sensor List.
3. If the sensor you attached to the interface is *not* in the picture with the interface, then click the input port into which you plugged the sensor. A drop down menu of sensors will appear. Select your sensor from the list of choices and the sensor's icon will be added to the picture of the interface.
- To *remove* the icon of a *ScienceWorkshop* sensor from the picture of the interface, click the sensor's icon and press the Delete key, or right-click the sensor's icon and select Remove Sensor.
 - To remove the icon of a PASPORT sensor from the picture of the interface, unplug the sensor from the interface, or right-click the sensor's icon and select Remove Sensor.

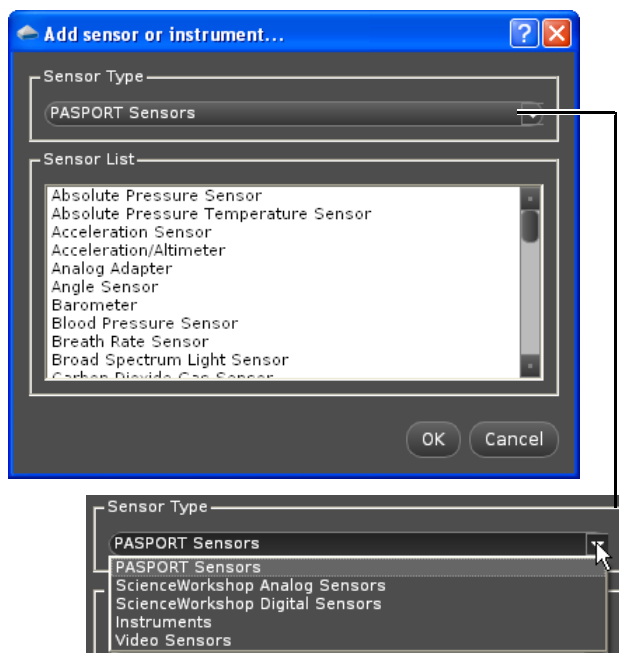

Sensor List and Sensor Types

4. Click the Setup button again to close the Hardware Setup panel.

B. Displays

Click and drag a Display icon from the Displays palette into the Workbook page, or click one of the eight QuickStart templates in the Workbook page.

The display choices include:

- Graph (X-Y data display)
- Scope (oscilloscope emulator)
- FFT (Fast Fourier Transform, or a frequency spectrum analyzer)
- Digits (digital meter)
- Meter (analog meter)
- Table (multi-column data display)
- Text (explanatory text display in the Workbook page)
- Text Entry (where the user can type information)
- Picture (digital image display)
- Movie (electronic video clip display)
- Placeholder (a blank display that holds a space for another display)



Refer to the Help menu or the online PASCO Capstone User's Guide for detailed information about each of the displays in the Displays palette.

Graph Display

For example, the Graph display has a Tool bar and other features such as selectable inputs for the vertical and horizontal axes. Hover the cursor over a Tool bar item to see its Tool Tip..

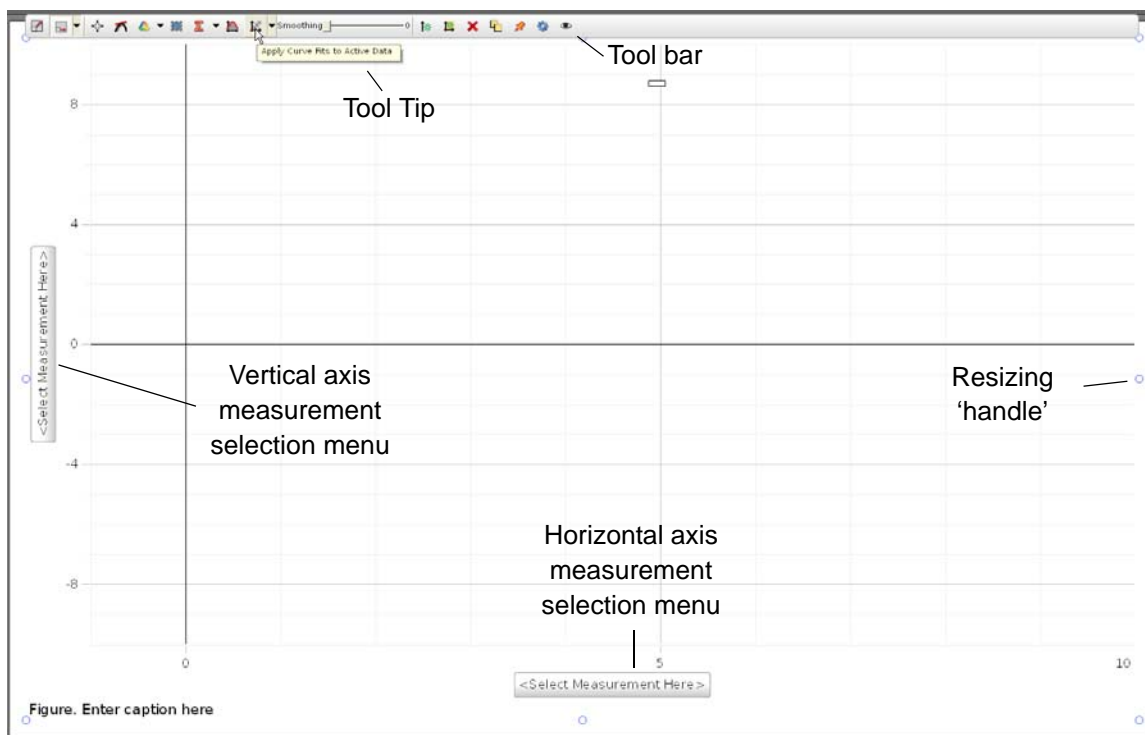

In addition to the Tool bar, the Graph display has 'handles' for resizing the display. Click anywhere in the Workbook page outside the Graph display to hide the Tool bar and 'handles'. Click anywhere in the Graph display to show the Tool bar and 'handles' again.

Axes Measurement Selection Menus

Each axis measurement selection menu shows options based on what sensors are used with the interface, and if the interface is being used as a signal generator. In this example, since a PS-2104 Force Sensor is connected, Force (N) could be selected for the vertical axis, and Time (s) for the horizontal axis.

The Equation/Constants drop down menu shows whatever equations, if any, have been created for the experiment, and shows a list of experimental constants from Speed of light (m/s) to neutron mass (kg).

Please see the online PASCO Capstone User's Guide for detailed information about the measurement selection menu, including QuickCalc.

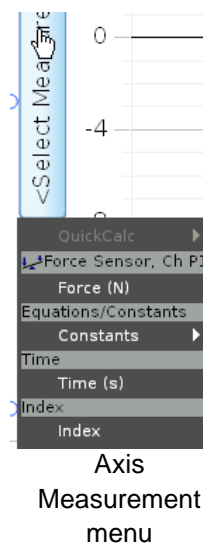

Graph Appearance Features.

Right-click in the plot area of the Graph display to show a menu of choices for the appearance of the plot area of the display. Select 'Plot Area Properties' to see more choices. Right-click on either axis to see the menu of appearance choices. Select 'Axis Properties' to see more choices.

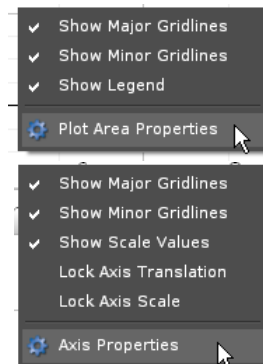

Plot Area and Axis Properties menus

C. Collect Data – the Controls Palette

1. Click the Record button at the left end of the Controls palette to begin collecting data.

- The Record button changes shape to become the Stop button.



Record button, Stop button, and Experiment clock

- The Experiment clock shows the elapsed time and indicates that the interface is recording.
- Data should appear in the display(s) in the Workbook page.

2. Click the Stop button to end data collection.

- The Stop button changes to a Record button and the Experiment clock resets.

3. Repeat the process to collect a second run of data.

- By default, the display will show the latest run of data.

4. To see a previous run of data in the display, click the Data Management button in the display's Tool bar and select the run (e.g., Run #2) from the menu.

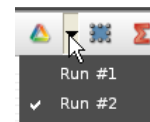

5. To delete a specific run of data, click the drop-down menu part of the Delete Last Run button in the Controls palette and select the run of data from the list.

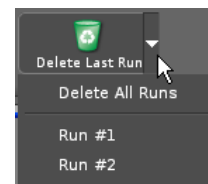

D. More Information About PASCO Capstone

Please see the online PASCO Capstone User's Guide for detailed information about the Graph display analysis tools, and the features of the other Displays and Tools.

For technical support, send an email message to:

techsupp@pasco.com or

support@pasco.com.

Using the 850 Interface as a Signal Generator

Output Ports – Front Panel

The PASCO 850 Universal Interface has three signal output ports on its front panel. Output Port 1 is a signal generator with a built-in power amplifier. It has two 4 millimeter (mm) banana jack ports that can provide ± 15 volts at up to 1 amp (or 15 watts) for a variety of waveforms (sine, square, triangle, ramp up, ramp down, etc.) or direct current (DC) if needed. The output frequency range for the waveforms is 0.001 hertz to 100,000 hertz (100 kHz) with a resolution of 0.001 Hz (1 mHz). The output has over-current detection and selectable current limiting (0.55, 1.10, and 1.50 A).

The interface also has two other signal generators with BNC connectors (Output Ports 2 and 3) that can provide ± 10 V at up to 50 mA (or 500 mW) for the various waveforms. The frequency range is from 0 to 500,000 hertz (500 kHz) for the sine wave, and from 0 Hz to a lower maximum frequency for the other waveforms. The resolution for the output frequency is 0.001 Hz.

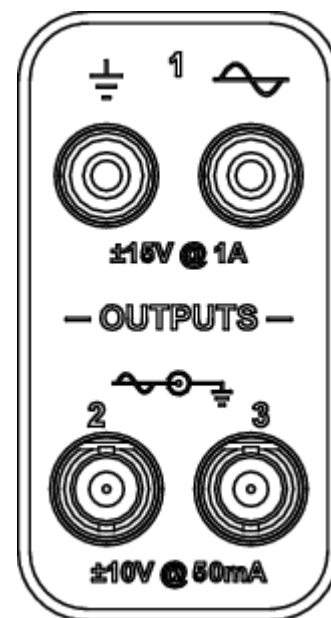

The output for all three signal generators is controlled by PASCO Capstone software. The interface can measure the output voltage for all three output ports, and can measure the output current for Output Port 1.



Output Ports

To use 850 Output 1 as a Signal Generator for a Circuit (or Other Device):

A. Connect the Interface

1. Insert a banana plug patch cord into the ground port () of Output 1 on the interface, and connect the other end of the cord to the ground on the circuit board (or other device).
2. Insert a banana plug patch cord into the signal generator port () of Output 1, and connect the other end of the cord to the positive lead on the circuit board (or other device).
3. In the PASCO Capstone Tools palette, click the Signal Generator button to open the Signal Generator panel.

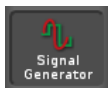

Signal Generator
button

- The panel has three drop-down menus, one for each of the three Output Ports of the 850 Interface.

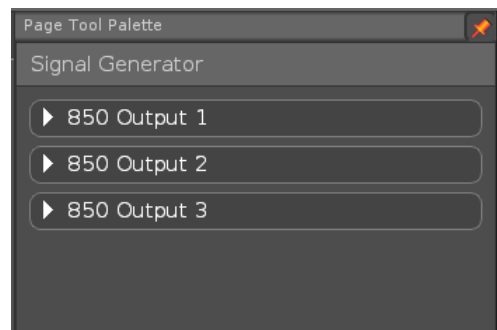

Signal Generator panel and
drop down menus

B. Signal Generator Controls: 850 Output 1

In the Capstone Signal Generator panel, click the 850 Output 1 drop down menu.

The Signal Generator 850 Output 1 panel shows the following controls:

Waveform	Voltage Offset
Sweep Type	Voltage Limit
Frequency	Current Limit
Amplitude	On, Off, Auto

Please see the online PASCO Capstone User's Guide for detailed information about these Signal Generator functions.

- **Waveform.** Sine (default), Square, Triangle, Positive Ramp, Negative Ramp, and DC.
- **Sweep Type:** Off (default), Single, Repeat, Bidirectional
- **Frequency:** Default: 1000 Hz; Range: 0.001 to 100 kilohertz* for AC waveforms
- **Amplitude:** Default: 1 V; Range: 0 to 15 V, depending on Voltage Limit.
- **Voltage Offset:** Default: 0 V; Range: 0 to 15 V, depending on Voltage Limit.
- **Voltage Limit:** Default: 15 V. Range: 0 to 15 V.
- **Current Limit:** 1.50 A (default), 1.10 A, and 0.55 A.
- **On, Off, Auto:** On starts the Signal Generator whether or not the Interface is recording data; Off (default) stops the Signal Generator; and Auto starts and stops the Signal Generator when the Interface starts and stops recording data.

*NOTE: The upper limit for the sine wave is 150 kHz. Although the Frequency text area goes up to 200000 Hz, the signal output above 150 kHz is diminished by about 50%.

Adjusting the Signal Generator Controls

Frequency, Amplitude, Voltage Offset, and Voltage Limit can be adjusted in more than one way.

Method #1

- Highlight the digits in the text area and then type in the desired value.



Highlight the digits; type in a value.

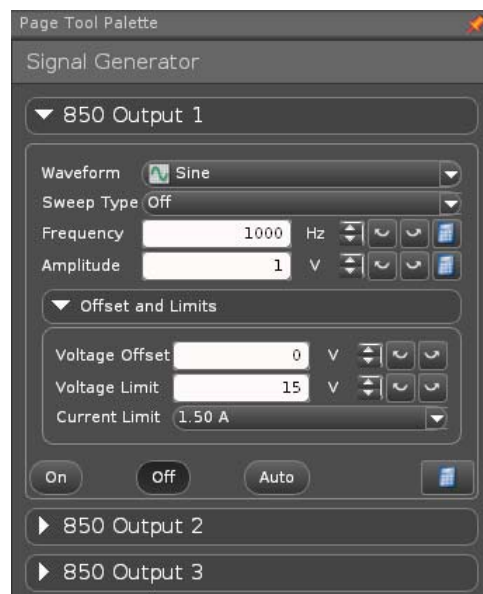

850 Output 1 panel

Method #2

- Use the Up and Down arrows to increase or decrease the individual digits. Use the Left and Right arrows to select the digit to change. By default, the “ones” (10^0) digit is selected..

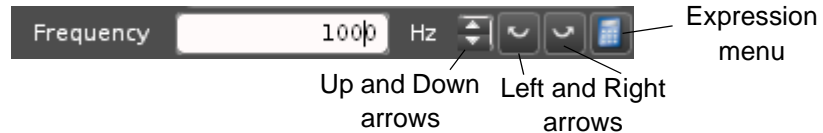

- Each click on the Up or Down arrows increases or decreases the highlighted digit by “1”.
- Click the Left arrow to move the selection of the highlighted digit to the left. The *left-most* digit that can be highlighted for Frequency is the “hundred-thousands” (10^5) digit. Click the Right arrow to move the selection of the highlighted digit to the right. The *right-most* digit that can be highlighted is the “thousandths” (10^{-3}) digit.

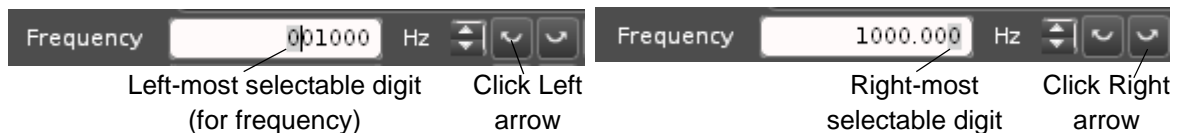

Method #3

- Click the Expression menu icon () to open the Expression menu. Select **Choose Expression** to select a calculation that has already been created from the submenu, or select **Create Expression** to build a calculation in the Frequency or Amplitude text areas. Click **Use Expression** to make the choice active.

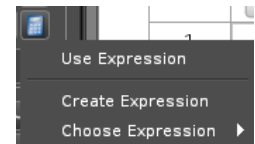

Sweep Type and Frequency

If you want the output frequency to change *automatically* from one frequency to another in specified increments over a selected time, select **Single**, **Repeat**, or **Bidirectional** from the Sweep Type menu.

- The **Single Sweep Type** starts at the **Initial Frequency** (default = 10 Hz) and moves to the **Final Frequency** (default = 100 Hz) in the time shown in **Duration** (default = 5 s), and with each new frequency increased or decreased by the amount shown in **Step Frequency** (default = 0.1 Hz).
- The **Amplitude** range is 0 (default) to 15 V. The **Frequency** ranges are the same as before. The **Duration** range is from 0.00001 to 10000 seconds.
- The **Repeat Sweep Type** behaves the same as the **Single Sweep Type**, except that it repeats itself continuously while the Signal Generator output is on.

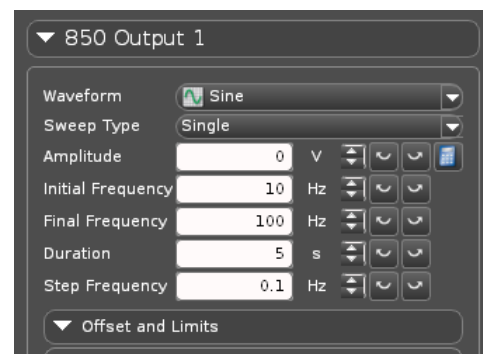

Sweep Type: Single

- The Bidirectional Sweep Type starts at the Initial Frequency, moves to the Final Frequency, and returns to the Initial Frequency – repeatedly – while the Signal Generator output is on.
- NOTE: The Initial Frequency can be lower or higher than the Final Frequency.

C. Signal Generator Controls: 850 Outputs 2 and 3

In the Capstone Signal Generator panel, click the 850 Output 2 drop down menu.

The Signal Generator 850 Output 2 panel shows the following controls:

Waveform	Amplitude
Sweep Type	Voltage Limit
Frequency	On, Off, Auto

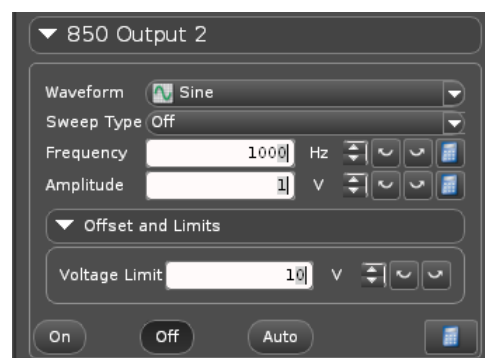

850 Output 2 panel

Please see the online PASCO Capstone User's Guide for detailed information about these Signal Generator functions.

- Waveform. Sine (default), Square, Triangle, Positive Ramp, Negative Ramp, and DC.
- Sweep Type: Off (default), Single, Repeat, Bidirectional
- Frequency: Default: 1000 Hz; Range: 0.001 to 500 kilohertz for AC waveforms
- Amplitude: Default: 1 V; Range: 0 to 10 V, depending on Voltage Limit.
- Voltage Limit: Default: 10 V. Range: 0 to 10 V.
- On, Off, Auto: On starts the Signal Generator whether or not the Interface is recording data; Off (default) stops the Signal Generator; and Auto starts and stops the Signal Generator when the Interface starts and stops recording data.

NOTE: Output 2 and Output 3 differ from Output 1 in the Frequency and the Amplitude range. Outputs 2 and 3 do not have the Voltage Offset and Current Limit controls. Also, the current output is limited to 50 milliamperes (mA). Otherwise, Output 2 and Output 3 operate the same way as Output 1.

Cables

Output 2 and Output 3 have BNC ports. You can connect the BNC plug of the UI-5119 BNC-to-Shrouded Banana Plug Cord or the UI-5219 BNC-to-Banana Plug Cord to either output port. You can connect the banana plugs to the circuit or other device.

Please see the online PASCO Capstone User's Guide for detailed information about the Signal Generator panel and the features of the other Controls, Displays, and Tools.

D. Set Up an Example Output Signal

1. Use the Signal Generator panel to set up an output signal. For this example, leave the Waveform as Sine, and the Sweep Type as Off, but change the Frequency to 1 Hz and the Amplitude to 2 V.
2. Click Auto so the Signal Generator will output the signal while you record data.
3. Click the Setup button in the Tools palette to open the Hardware Setup panel.
4. Click the left-hand banana jack of Output 1 in the picture of the 850 Universal Interface to open the sensor menu.
5. In the menu, click Output Voltage Current Sensor.

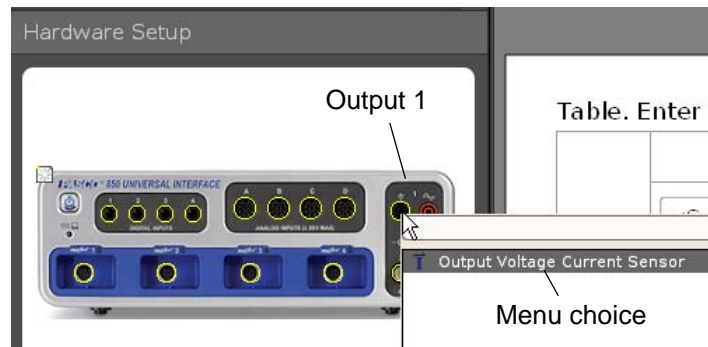
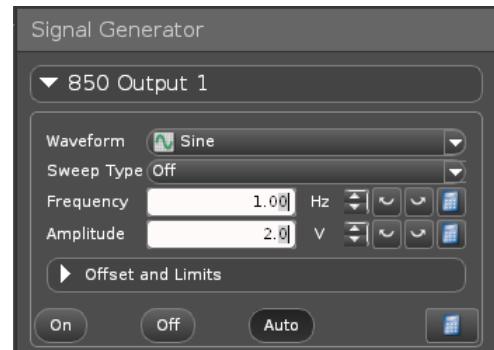

- The icon of the Voltage Current Sensor appears with the picture of the interface in the Hardware Setup panel.

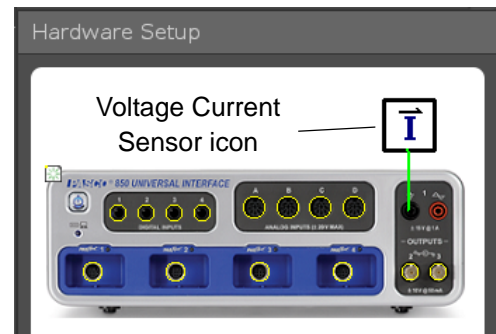

E. View the Output Signal in a Capstone Display

1. Set up a Graph display in the Workbook page.
2. Use the Horizontal Axis Measurement Selection Menu to select Time for the horizontal axis.
3. Click the Vertical Axis Measurement Selection Menu. *Notice that the menu shows choices for the output signals.*
 - The choices under Output Voltage Current Sensor, Ch 01 are Output Voltage (V) and Output Current (A).
4. Select Output Voltage (V) for the vertical axis.
5. Once the Graph display is set up to show Output Voltage on the vertical axis and Time on the horizontal axis, click Record to begin collecting data.
 - The Record control changes to Stop, and data points appear in the Graph display.

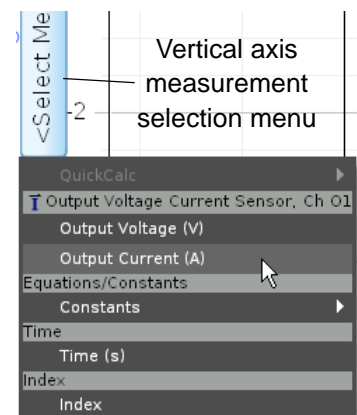

6. After ten seconds or so, click Stop to end data recording. Adjust the Graph display as needed.

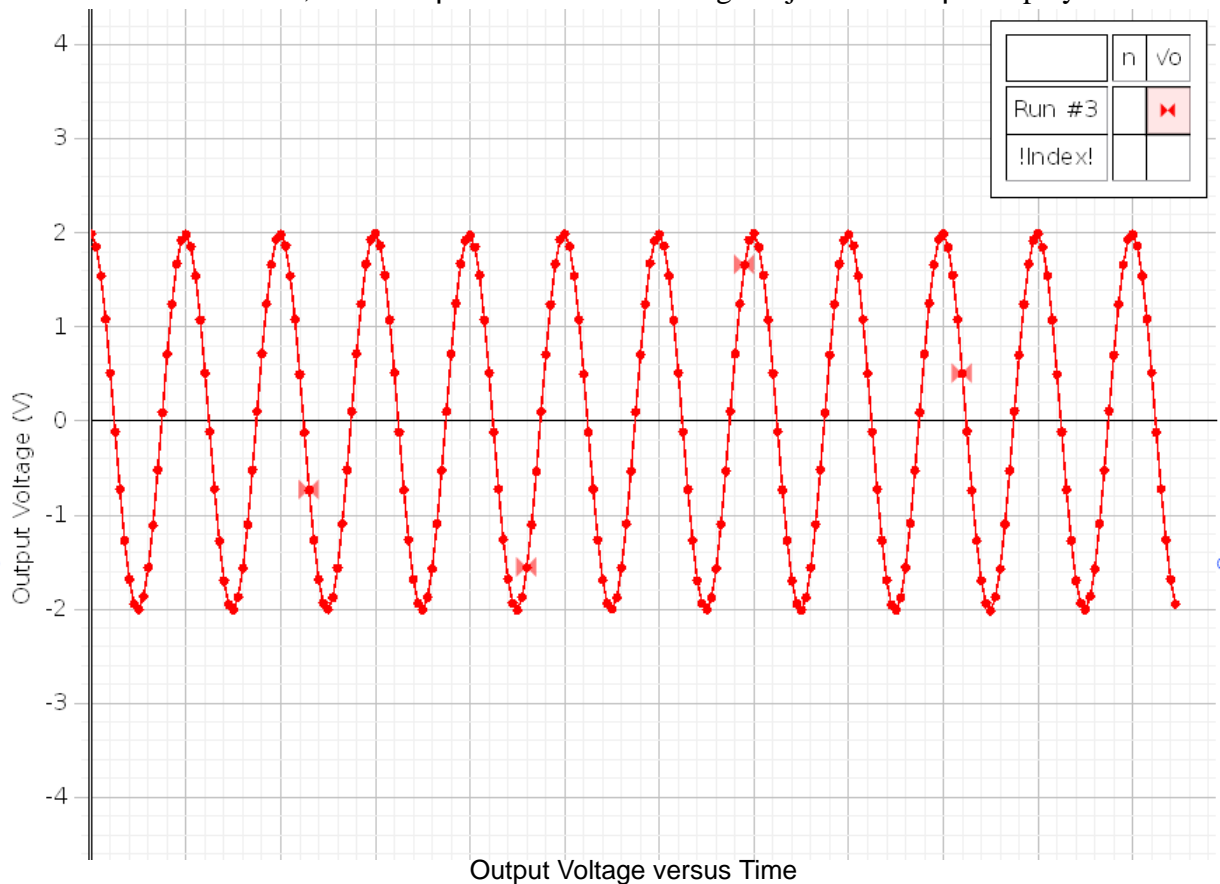

Hints for Help

- Please see the online PASCO Capstone User’s Guide for detailed information about PASCO Capstone and the features of the Controls, Displays, Tools, palettes, and panels. Use the Help menu to access the online User’s Guide.
- Hover the cursor over an item to see its Tool Tip.
- Right-click on an item to see its contextual menu.

Troubleshooting

Problem	Recommendations
The interface does not turn on.	Ensure you have the power supply connected between the interface and a standard, grounded outlet. Check to see that the power push button is pushed in. Ensure that the USB cable is inserted properly to both the interface and to a USB port of your computer.

Problem	Recommendations
My computer's operating system does not recognize the interface and asks for a driver.	You must have Capstone version 1.0 software loaded onto your computer. Capstone 1.0 includes a driver (set of software instructions) that allow your computer to communicate with the 850 Universal Interface. Check "Computer Requirements" in this manual to ensure your operating system is compatible with USB devices.
Capstone does not allow me to collect data with the interface connected.	Recheck the USB cable and power connections. Also, check to ensure you have the proper hardware setup selected in Capstone. In the Hardware Setup panel, click Choose Interface . See that Autodetect is checked, or click the More menu and see which interface is connected.
I want to collect data with both a 750 USB Interface and the 850 Universal interface simultaneously.	Capstone does not allow you to collect data from a <i>ScienceWorkshop</i> interface and other interfaces simultaneously. Instead, use the Choose Interface button in the Capstone Hardware Setup panel to alternate between interfaces.
I am unable to output a signal from the Signal Generator.	Check the Signal Generator panel to ensure you have selected On or Auto . Also check that the Amplitude is not "0". Also, check the Sweep Type and the Duration . If the Sweep Type is Single , the output signal will occur only one time. If the Duration is zero, there will be no signal.
The selected Display does not show any data after I click Record.	Check the <Select Measurement Here> menu for both the vertical and horizontal axes. Depending on what sensors are connected and the setup for the Signal Generator , each menu will have choices for you to select.

Appendix A: Specifications

850 Universal Interface	Description
Power:	100-240 V AC to 20 V DC at 6 A, 2.1 mm jack
Computer Connection:	Universal Serial Bus (USB) 2.0 high speed (480 Mbps); does not use any bus power
PASPORT Input Channels:	Four PASPORT connections support all PASPORT sensors. Each port can supply up to 150 mA at 5 V. Maximum sampling rate greater than or equal to 50,000 samples per second (50 ksps)
ScienceWorkshop Digital Channels:	Four input/output channels. Supports all <i>ScienceWorkshop</i> digital sensors. +5 V at 200 mA total for all four channels. Digital input: Edge sensitive and sampled at 10 kHz (100 μ s), (1 μ s resolution for the Motion Sensor).
ScienceWorkshop Analog Channels:	Four identical channels with differential inputs and 1 megaohm input impedance. Supports all <i>ScienceWorkshop</i> analog sensors. ± 20 V input voltage measurement range. Input protection: ± 250 V continuous & common mode. Four voltage gain settings on each channel (1, 10, 100, and 1000). Bandwidth: Unity gain; 500 kHz.
Analog Measurement (all sources):	Dual 14-bit analog-to-digital converters (ADC), 2.5 mV resolution. Maximum sample rate: two channels at 10 million samples per second (Msps) simultaneously. Maximum rate depends on how many channels are selected for each ADC. Trigger on any analog event (input or output), or digital event. Window buffer allows pre-trigger sampling. Eleven sources: four "CI-" analog inputs, three external inputs, three analog outputs, one current output.

Voltage Output, 15 watt (W):

Amplitude range: ± 15 V with 7.3 mV resolution, 12-bit digital-to-analog converter (DAC).

Maximum output current: 1 A with over-current detection.

Selectable current limits: 1.5 A, 1.1 A, and 0.55 A.

Frequency range: 0.001 to 100,000 Hz with 0.001 Hz resolution.

Voltage offset: ± 15 V, sum of output plus offset is less than or equal to ± 15 V.

Waveforms: sine, triangle, variable duty cycle square, positive ramp, negative ramp, DC.

Sweep functions: single, repeatable, bidirectional.

Output disable function.

Output current measure: 61 μ A resolution.

Voltage Output, low power:

Two independent channels, each with 12-bit DAC.

Amplitude range: ± 10 V, 2.5 mV resolution.

Maximum output current: ± 50 mA.

Frequency range: 0.001 to 500,000 Hz for sine (lower maximum for other waveforms), with 0.001 Hz resolution.

Outputs available on front panel BNC jacks and the external module connector on the back panel.

Input/Output Expansion Module:

On the back panel, the 44 pin high density connectors with twisted pairs supplies the following:

Eight independent Input/Output (I/O) pins, + 3.3 V or + 5 V CMOS logic levels.

Function generator, 15 W.

Two channels of independent low power function generator, ± 10 V.

Three channels of analog differential input, unity gain, ± 10 V. Small signal (1 V peak-to-peak sine) band width is 350 kHz. Large signal (5 V p-p sine) band width is 50 kHz.

Input impedance: 2 megaohm.

High speed master SPI channel for communication.

Power sources: + 5 V at 500 mA, ± 12 V at ± 300 mA.

External Trigger Output/Input:

On the back panel, the BNC jack can be used to trigger external events or synchronize multiple 850 Interfaces.

Signal direction under host software control.

Trigger is a 3.3 V transistor-to-transistor logic (TTL) signal, has a 51 ohm series termination, and has electrostatic discharge (ESD) protection.

Appendix B: Compliance

This equipment has been tested and found to comply with the limits for a Class A digital device, pursuant to part 15 of the Federal Communications Commission (FCC) Rules. These limits are designed to provide reasonable protection against harmful interference when the equipment is operated in a commercial environment.

This equipment has also been tested and found to comply with the pertinent European Standards, specifically, the following:

Council Directive 2004/108/EC related to Electromagnetic Compatibility

- Radiated Emissions: Regulation Standard: EN55022, CISPR22.
- Immunity: Basic Levels related to Electrical Equipment for Measurement, Control and Laboratory use: General Requirements; EN 61326-1:2006 (IEC 61326-1:2005).
- EN 61000-4-2:2001 (IEC 61000-4-2:2001) ESD Discharge
- EN 61000-4-3:2002 (IEC 61000-4-3:2002) Radiated Immunity
- EN 61000-4-4:2004 (IEC 61000-4-4:2004) EFT Burst
- EN 61000-4-5:2001 (IEC 61000-4-5:2001) Surge Immunity
- EN 61000-4-6:2007 (IEC 61000-4-6:2003) Conducted Immunity
- EN 61000-4-11:2004 (IEC 61000-4-11:2004) Voltage Dips
- EN 61000-4-11:2004 (IEC 61000-4-11:2004) Voltage Interruptions

Council Directive 2006/95/EC related to Low Voltage Safety

Appendix C: Frequently Asked Questions

What is the 850 Universal Interface?

The PASCO 850 Universal Interface is designed to meet the needs of those users who want to use any of the PASCO sensors in any combination at the same time. The interface has twelve input ports, three output ports, a trigger In/Out port, and a special input/output port that is user-definable.

The PASCO 850 Universal Interface can measure data at a rate as fast as ten millions sample per second (10 Msps), and can output a signal at a frequency as high as five-hundred thousand hertz (500 kHz).

How do I know if my computer has a USB port?

If your computer has a USB port, you will see the USB symbol () embossed, engraved, or printed next to the port somewhere on your computer. If you purchased a computer that was manufactured in 2001 or later, chances are you have a USB-compatible computer.

It may be possible to add USB ports to your computer using a USB interface card.

My computer has two USB ports. Can I use more than one PASCO USB interface at the same time?

Yes. PASCO Capstone software allows you to use more than one PASCO USB interface at the same time. However, only one 750 USB *ScienceWorkshop* Interface or 500 *ScienceWorkshop* Interface with a USB/Serial adapter can be used with Capstone.

Is the 850 Universal Interface compatible with PASCO's complete line of sensors?

Yes. The 850 Universal Interface is compatible with PASPORT sensors ("PS-") and ScienceWorkshop ("CI-") sensors.

Does the 850 Universal Interface work with *other* software?

No. The 850 Universal Interface requires PASCO Capstone software.

Does PASCO Capstone software work with *other* interfaces?

Yes. PASCO Capstone software works with any PASPORT interface such as the USB Link and the SPARK Science Learning System (SLS). The software also works with a 750 USB *ScienceWorkshop* Interface or a 500 *ScienceWorkshop* Interface with a USB/Serial adapter.

PASCO Capstone software will work with the PASCO PI-8127 Function Generator and with USB compatible video cameras.

If I have the 850 Universal Interface and some PASPORT interfaces connected at the same time, which interface would be recognized first and have priority?

PASCO Capstone software would give *equal* recognition to all PASPORT interfaces and the Select Measurement Menu in a Capstone display will list all of the sensors for all the recognized interfaces.

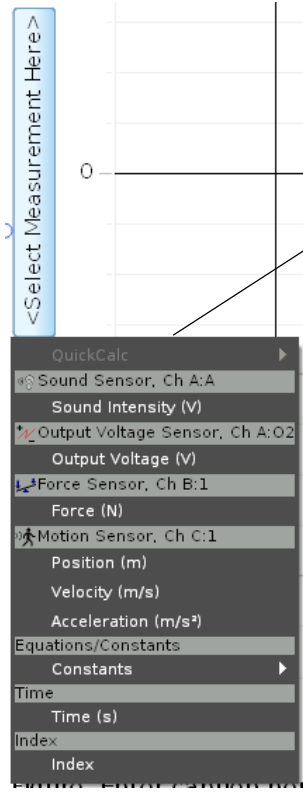
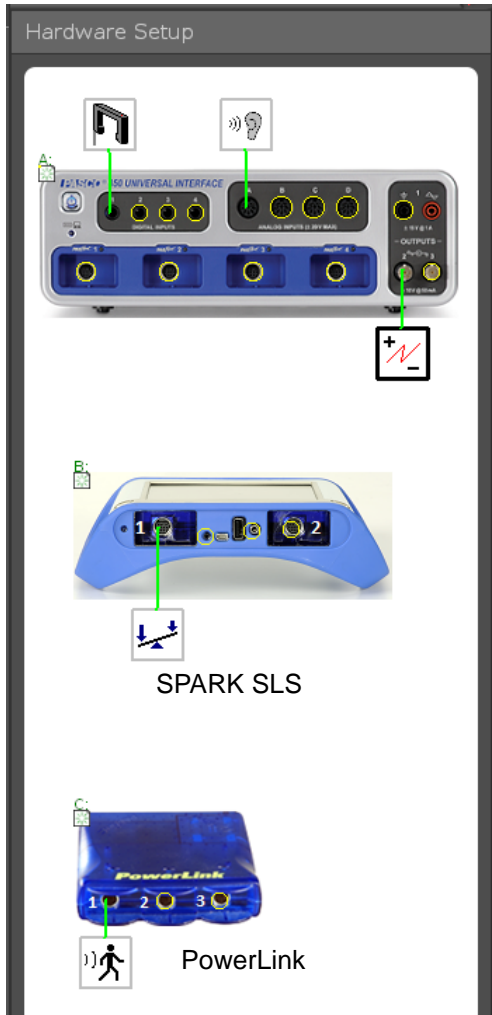

<Select Measurement Here> menu for a Graph display vertical axis

NOTE: The menu shows the Sound Sensor in Analog Channel A (Ch A) and the Output Voltage Sensor for Output 2 (O2) for the 850 Interface (A), the Force Sensor in Channel 1 for the SPARK SLS interface (B), and the Motion Sensor in Channel 1 for the PowerLink interface (C).

Technical Support

For assistance with any PASCO product, contact PASCO at:

Address: PASCO scientific
10101 Foothills Blvd.
Roseville, CA 95747-7100

Phone: 916-786-3800 (worldwide)
800-772-8700 (U.S.)

Fax: (916) 786-7565

Web: www.pasco.com

Email: support@pasco.com

For the latest information about this product or the latest revision of the Instruction Manual, visit the PASCO web site and enter UI-5000 in the Search window.

Limited Warranty For a description of the product warranty, see the PASCO catalog.

Copyright The PASCO scientific 012-12355A 850 Universal Interface Instruction Manual is copyrighted with all rights reserved. Permission is granted to non-profit educational institutions for reproduction of any part of this manual, providing the reproductions are used only in their laboratories and classrooms, and are not sold for profit. Reproduction under any other circumstances, without the written consent of PASCO scientific, is prohibited.

Trademarks PASCO, PASCO scientific, Capstone, ScienceWorkshop, DataStudio, PASPORT, and SPARK Science Learning System are trademarks or registered trademarks of PASCO scientific, in the United States and/or in other countries. All other brands, products, or service names are or may be trademarks or service marks of, and are used to identify, products or services of, their respective owners. For more information visit www.pasco.com/legal.

Product End of Life Disposal Instructions:

This electronic product is subject to disposal and recycling regulations that vary by country and region. It is your responsibility to recycle your electronic equipment per your local environmental laws and regulations to ensure that it will be recycled in a manner that protects human health and the environment. To find out where you can drop off your waste equipment for recycling, please contact your local waste recycle/disposal service, or the product representative.



The European Union WEEE (Waste Electronic and Electrical Equipment) symbol on the product or its packaging indicates that this product **must not** be disposed of in a standard waste container.